

INSTALLATION INSTRUCTION

Item No. : 872CH-5V

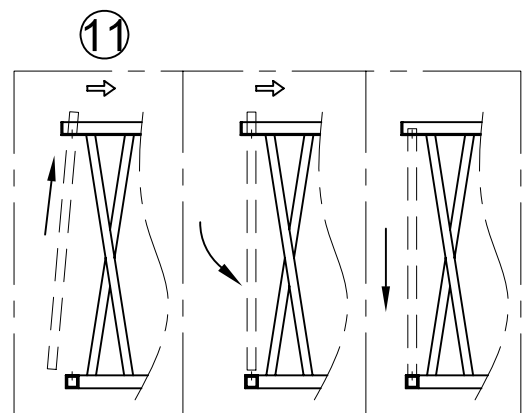
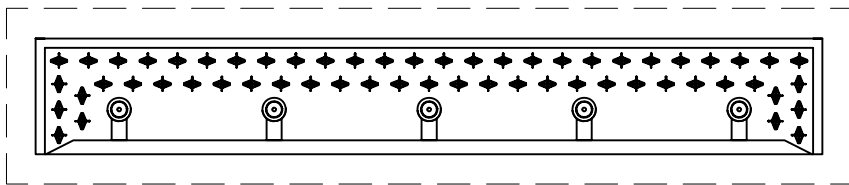
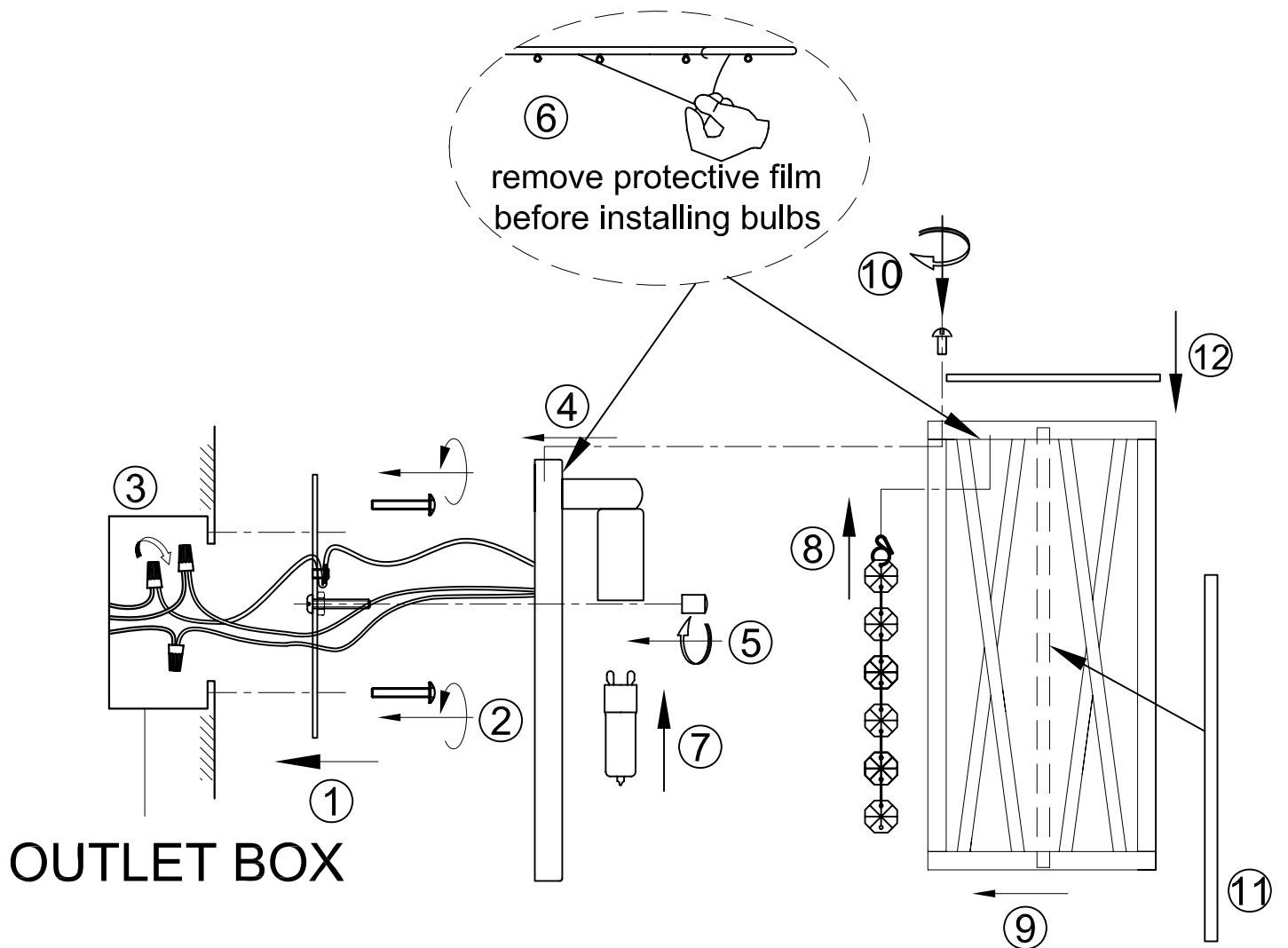

FEATURE

- 120V ~ 60Hz
 - Lamp Type: "Xenon" G9 5 × MAX 40W
- The lamp is for indoor use only